

AF1210

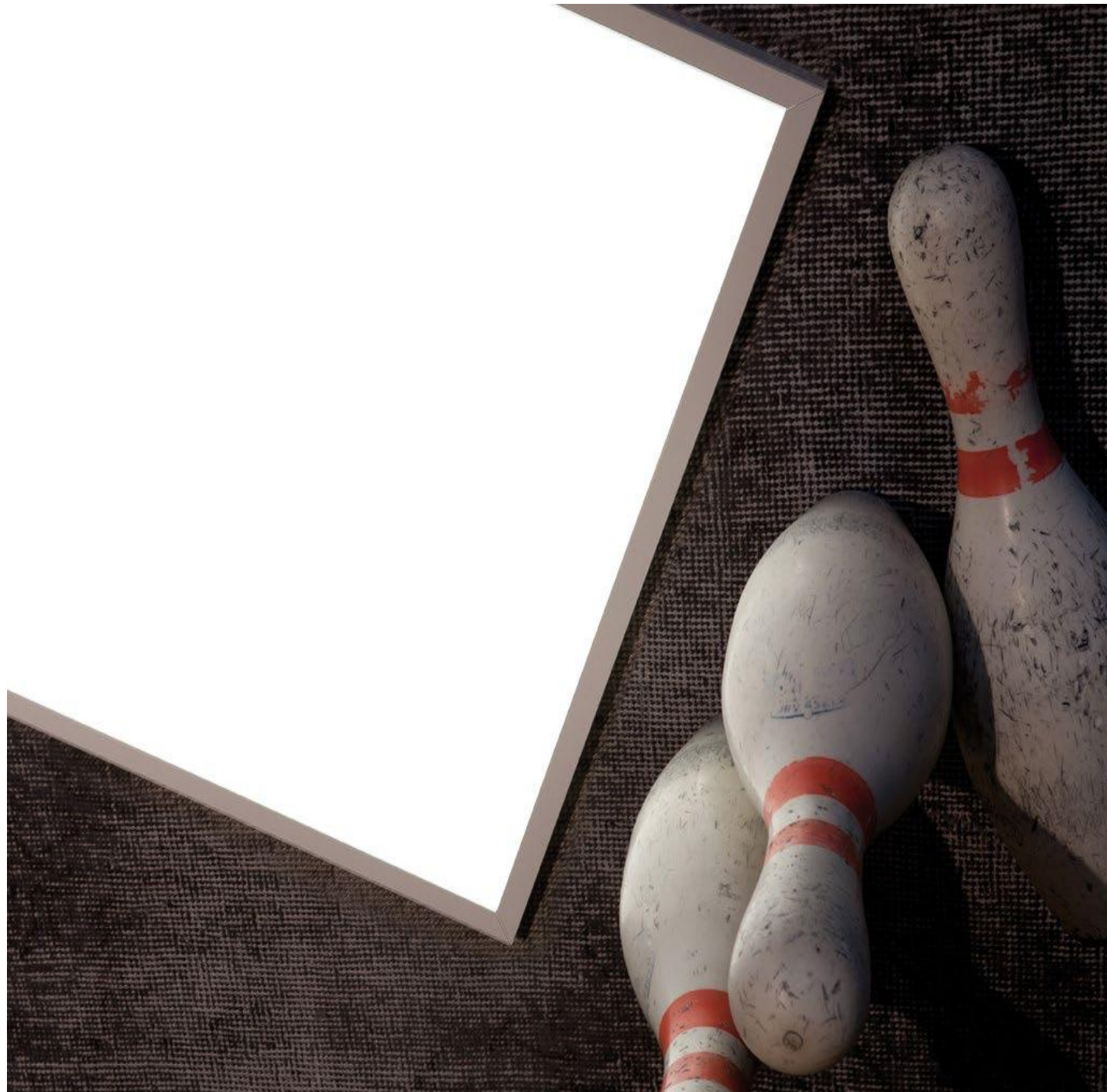

 **YEEHUI**<sup>®</sup>

熠熠生辉 铮铮入梦



熠熠生辉

铮铮入

梦

[WWW.yh-lighting.cn](http://WWW.yh-lighting.cn)



# 应用场景

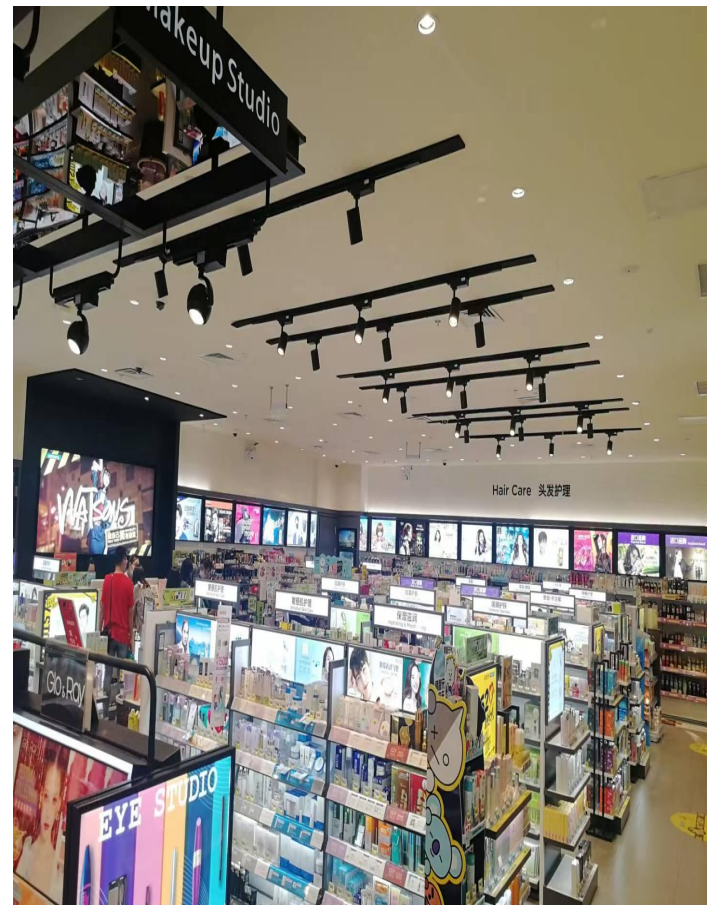
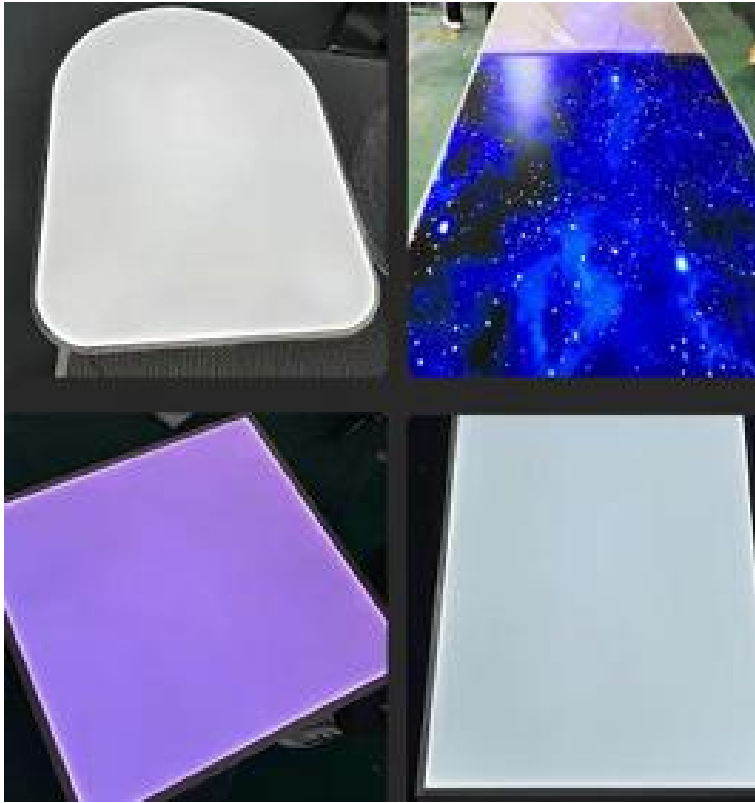

外框是铝材材质，表面阳极氧化处理，银色、白色、黑色银可定制RAL上面颜色。

面板表面是乳白色扩散板，可选择PC、PMMA材质，厚度为0.3、0.8、1、2、3

导光板透明三菱全新料生产，表面激光打点加工，入光边可选择单边、双边、四边。

背板表面乳白色，PET、PP、PVC材质，厚度有0.188、0.25、1mm。

光源铜板软光条每米10-26W选择，电压DC12V、24V，色温正白，暖白，冷白，RGB可选择。

端子线UL2468、20AWG\22AWG黑色双并线，DC5525、DC5521公母选择

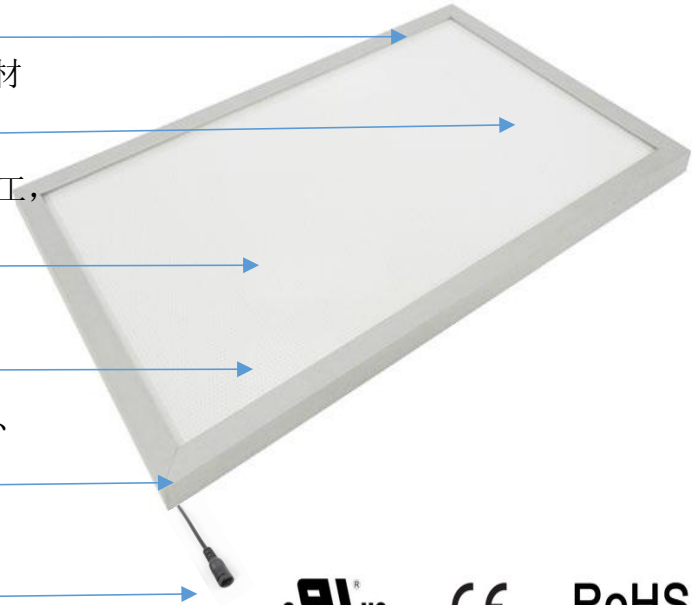

### 可定制尺寸

从50 x 100mm的任何尺寸到  
2000 x 3000mm

### 使用寿命

正常使用超过50000小时

### 高效节能

比普通的荧光灯管节约70%

## 灯具截面结构

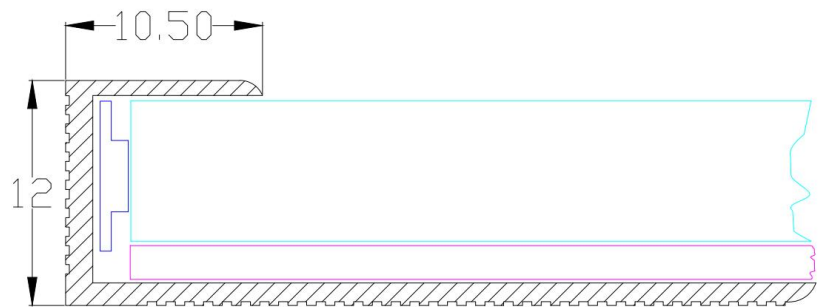

# AF1210

# 参数说明:

## 单边入光发光板

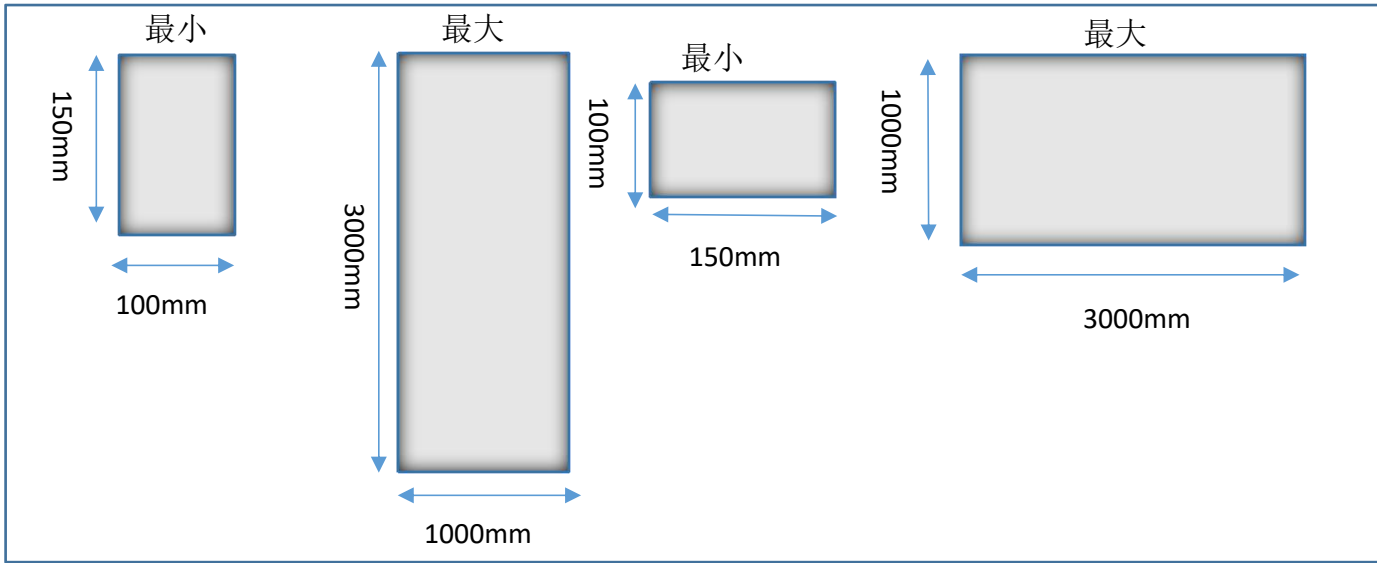

### 机械性能

厚度: 12 mm  
 长度:      mm 宽度:      mm  
 重量:      kg

### 电气性能

驱动电压: AC110-220V转换DC12-24V  
 输入电压: DC12、DC24  
 功率消耗: 12W/m

### 光源参数

输入光通量: 2000LM  
 输出光通量: 同比输入减少损耗27%

色温: CCT、3200、4500、6500、9000K、  
 12000K、RGB、RGBW、RGBWW  
 显色指数: 80-85CRI、90-95CRI

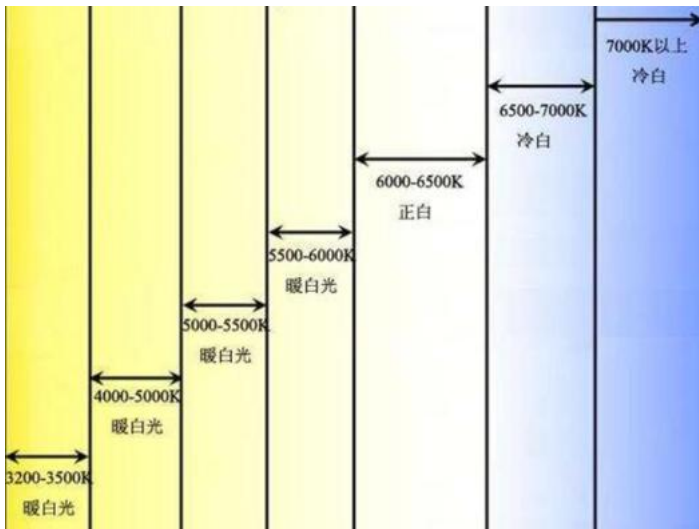

### 入光方式

单长边入光      双长边入光      四边  
 单短边入光      双短边入光

### 安装方式

侧挂	磁吸	挂钩
吊挂	磁吸	钢丝吊码
平铺	地面	台面

### 使用环境

室内  
 室外

### 测试认证

认证: CE CCC ROHS UL  
 阻燃等级: HB V0  
 防水等级: IP40 IP67

### 使用寿命:

正常使用大于等于50000小时

### 保修期:

指定环境中保质期24个月

**注意:** 如有特殊要求请及时联系我司技术人员, 他会制定一个属于你的专属的产品!

# AF1210

# 参数说明:

## 双边入光发光板

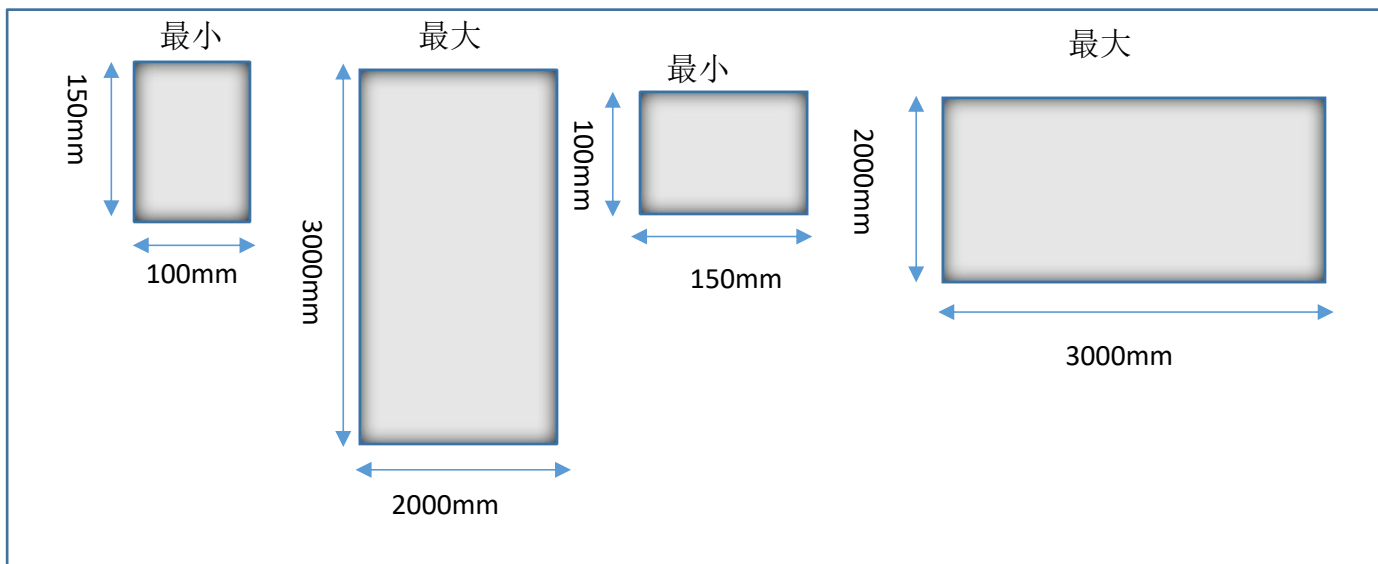

### 机械性能

厚度: 12 mm  
 长度:      mm 宽度:      mm  
 重量:      kg

### 电气性能

驱动电压: AC110-220V转换DC12-24V  
 输入电压: DC12、DC24  
 功率消耗: 12W/m

### 光源参数

输入光通量: 2000LM  
 输出光通量: 同比输入减少损耗27%

色温: CCT、3200、4500、6500、9000K、  
 12000K、RGB、RGBW、RGBWW  
 显色指数: 80-85CRI、90-95CRI

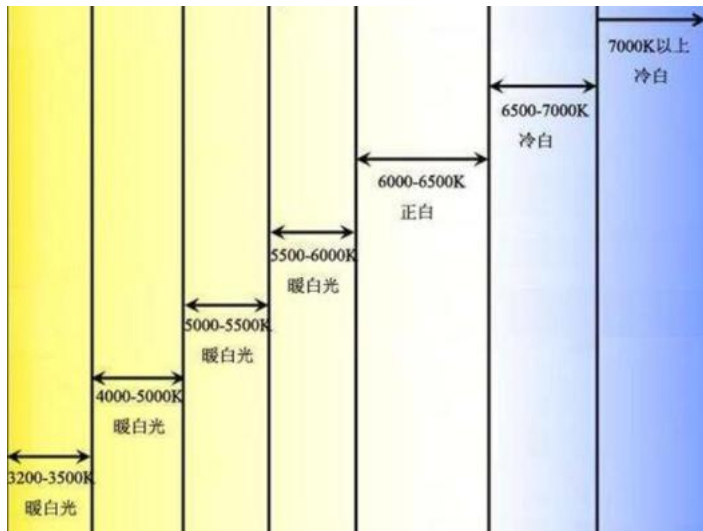

### 入光方式

单长边入光      双长边入光      四边  
 单短边入光      双短边入光

### 安装方式

侧挂	磁吸	挂钩
吊挂	磁吸	钢丝吊码
平铺	地面	台面

### 使用环境

室内  
 室外

### 测试认证

认证: CE CCC ROHS UL  
 阻燃等级: HB V0  
 防水等级: IP40 IP67

### 使用寿命:

正常使用大于等于50000小时

### 保修期:

指定环境中保质期24个月

**注意:** 如有特殊要求请及时联系我司技术人员, 他会制定一个属于你的专属的产品!

# AF1210

# 参数说明:

## 四边入光发光板

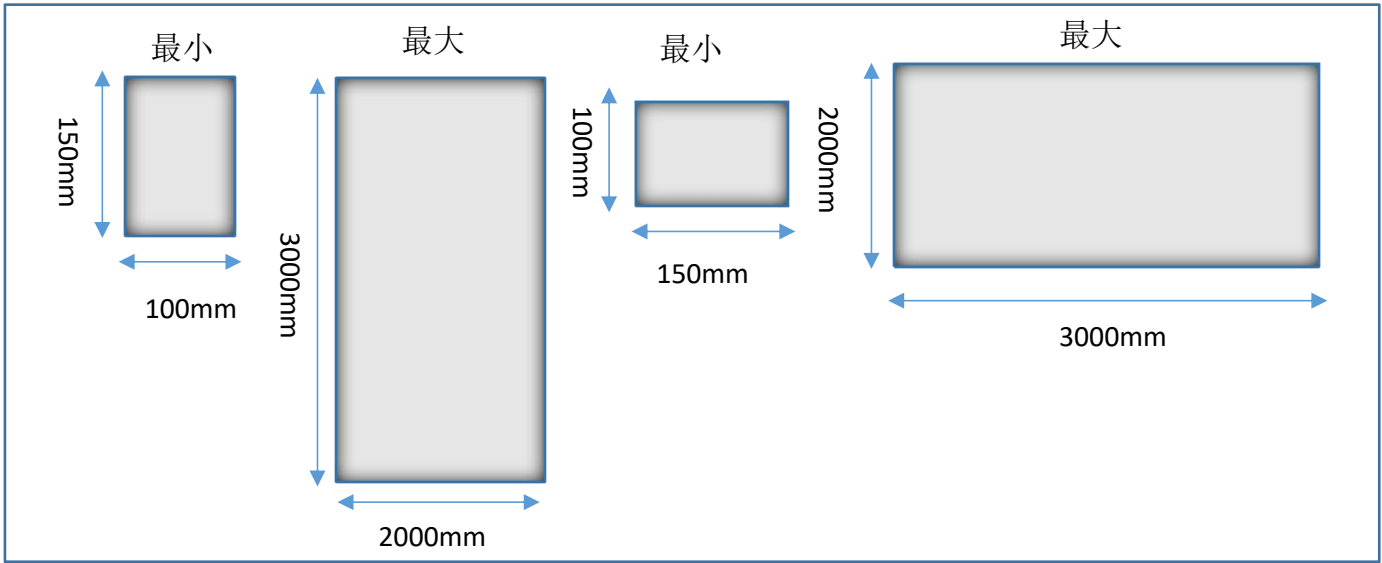

### 机械性能

厚度: 12 mm  
 长度:      mm 宽度:      mm  
 重量:      kg

### 电气性能

驱动电压: AC110-220V转换DC12-24V  
 输入电压: DC12、DC24  
 功率消耗: 12W/m

### 光源参数

输入光通量: 2000LM  
 输出光通量: 同比输入减少损耗27%

色温: CCT、3200、4500、6500、9000K、  
 12000K、RGB、RGBW、RGBWW  
 显色指数: 80-85CRI、90-95CRI

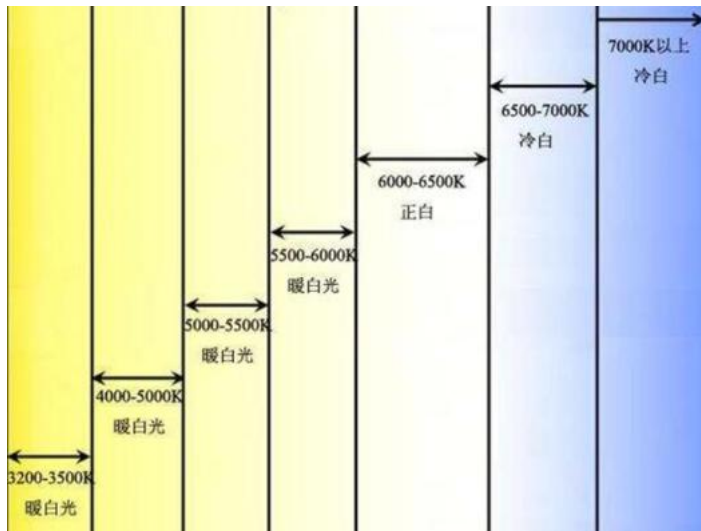

### 入光方式

单长边入光      双长边入光      四边  
 单短边入光      双短边入光

### 安装方式

侧挂	磁吸	挂钩
吊挂	磁吸	钢丝吊码
平铺	地面	台面

### 使用环境

室内  
 室外

### 测试认证

认证: CE CCC ROHS UL  
 阻燃等级: HB V0  
 防水等级: IP40 IP67

### 使用寿命:

正常使用大于等于50000小时

### 保修期:

指定环境中保质期24个月

**注意:** 如有特殊要求请及时联系我司技术人员, 他会制定一个属于你的专属的产品!

# AF1210

# 技术参数

性能参数表		
序号	项目	描述
01	(电源)	
02	(输入功率)	
03	(光通量)	> 2000LUX
04	(色温)	
05	Life Time (使用寿命)	>50,000 Hour
06	(工作环境温度)	-10 to +40°C
07	(储存温度)	-20 to +60°C
08	(工作湿度)	90%
09	(储存湿度)	90%
10	(LUX高照度)	
11	(净重)	
12	(尺寸)	mm
13	(安装方式)	嵌入 吸顶 吊装 侧挂



# 光源描述:

型号	颜色	线路板宽度 (mm)	线路板长度 (mm)	直流电压 (V)	单颗灯珠功率(W)
Item	Color	PCB Width	PCB Length	DC Voltage	Power per lamp
	正白光 Natural white		500	12/24V	0.5

LED多个型号选择  
寿命可达到50000  
小时以上

基板按照UL  
标准严格把  
关纯铜制作

基板有多种材  
质, 宽度选择  
3-12mm

## Dimension

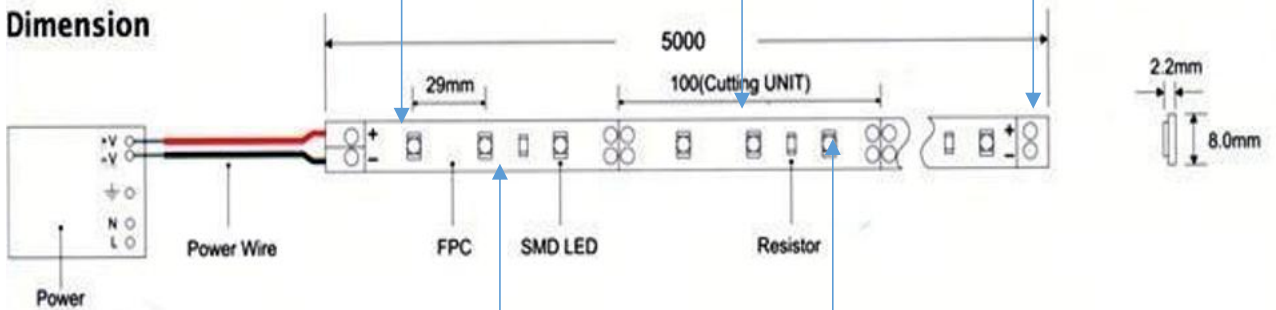

所有电路设计都是有  
YEEHUI自主  
研发生产

灯珠多个品  
牌选择



LED灯条参数 RL-835-12V-120D-W6-1000*5					
灯珠规格	28*35mm				
基板规格	1000*5mm				
发光角度	120度				
显色指数	80CRI	85 CRI	90CRI	95CRI	
光衰减	6000小时≤3% 10000小时≤15% 15000小时≤30% 50000小时≤30%				
单灯瓦数	0.5w				
单灯流明	10-12Lm				
色温	3000K	4000K	6000K	2700-6500	RGB

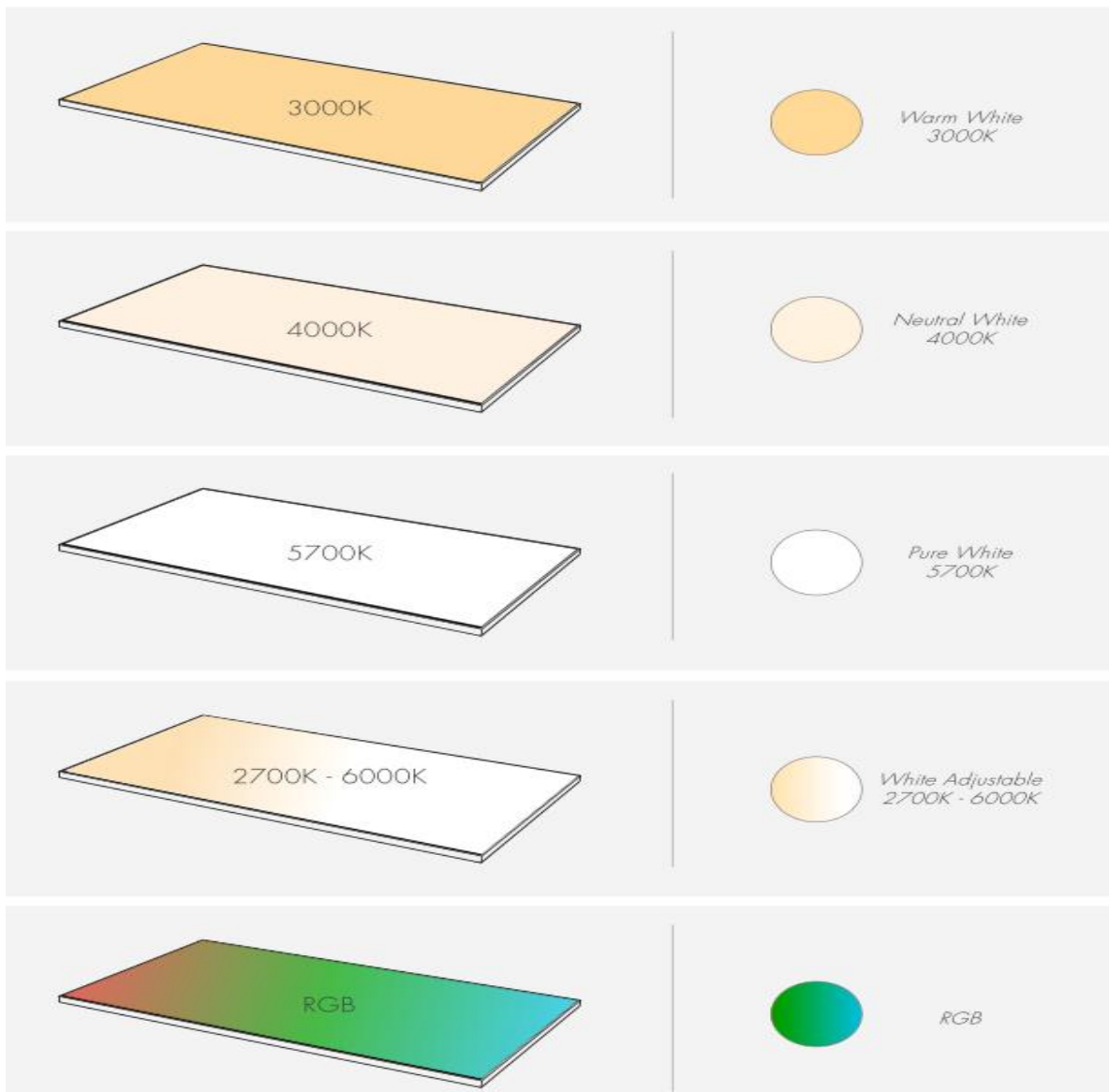

# 出线详图



详细件12页

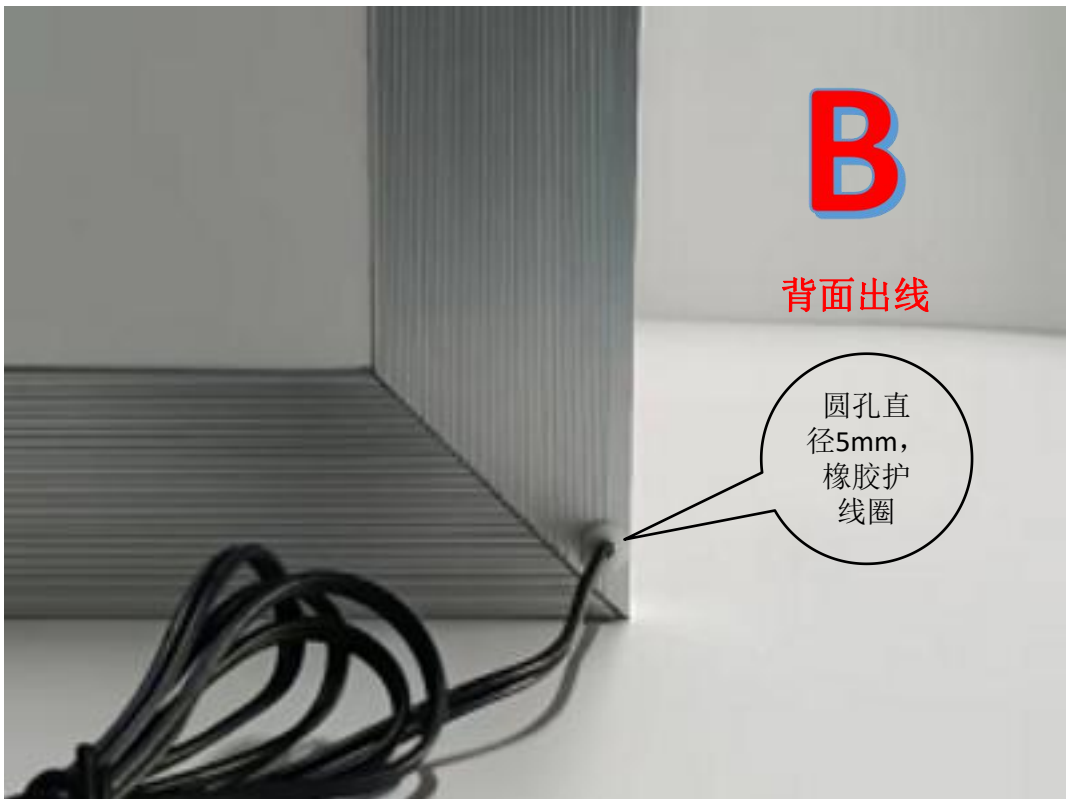

详细件13页

# 侧面出线示意图

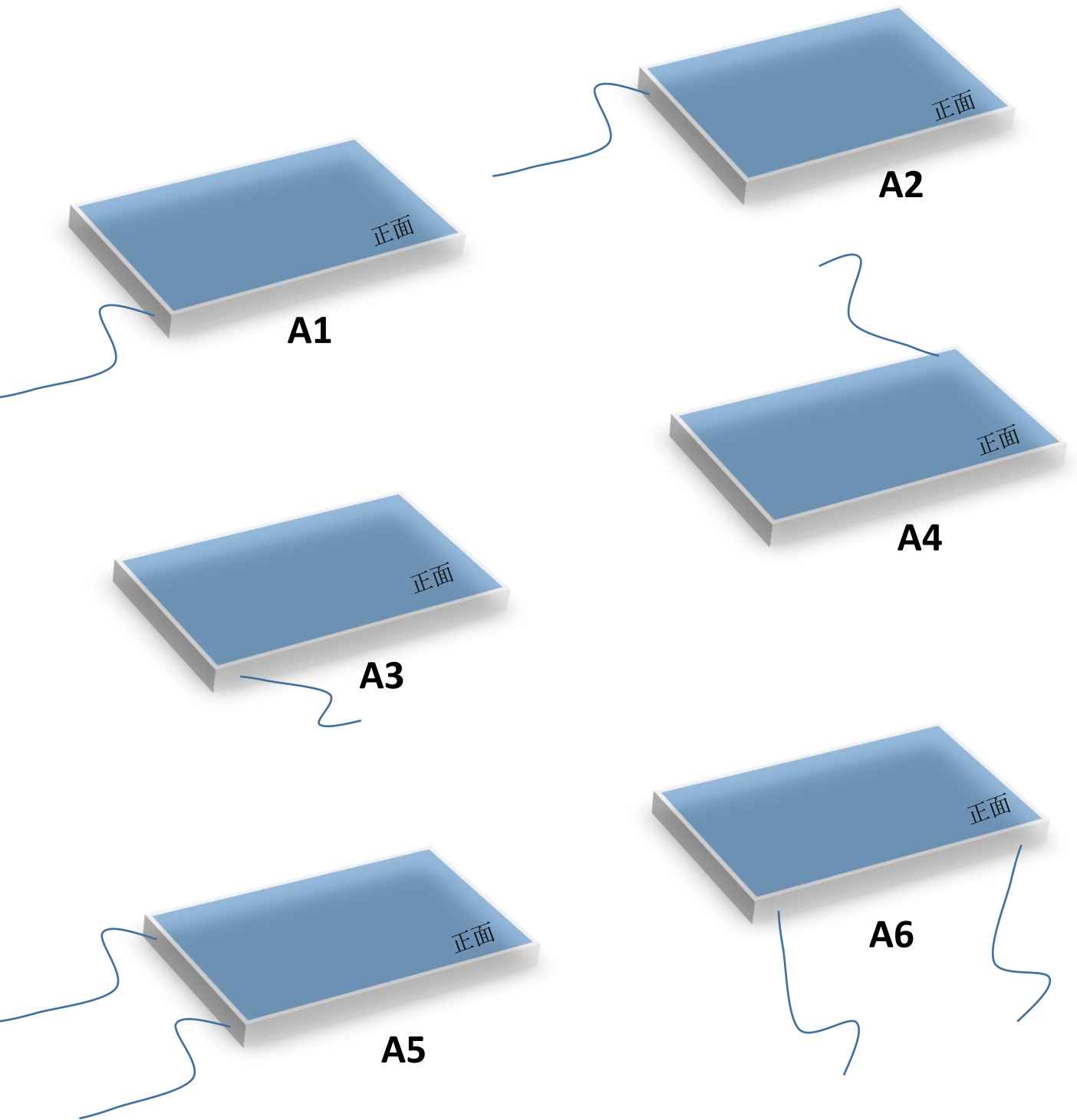

# 背面出线示意图

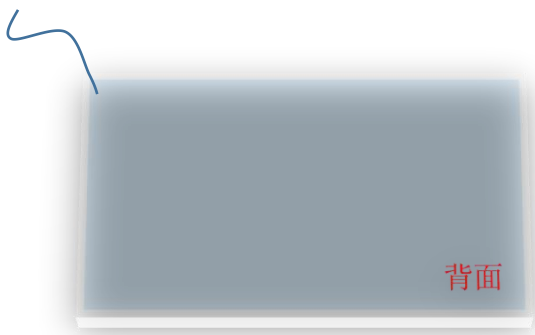

**B1**



**B2**

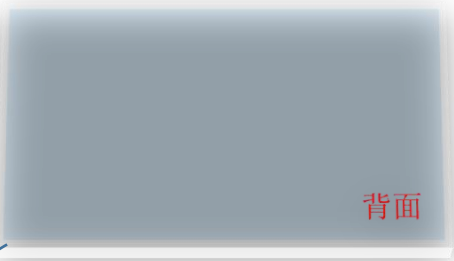

**B3**

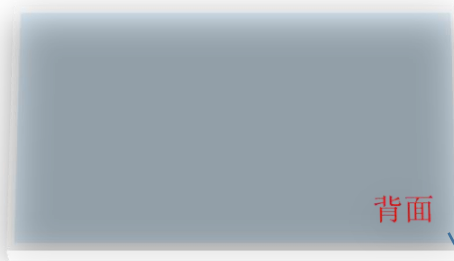

**B4**

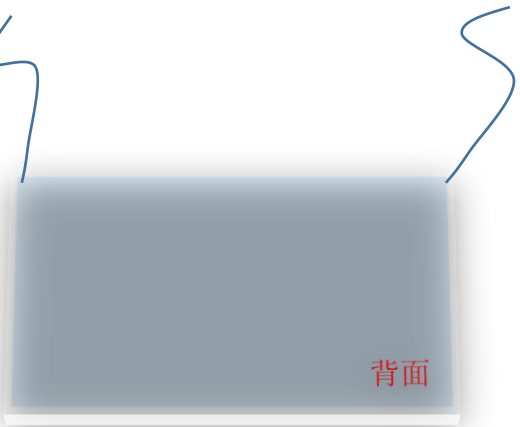



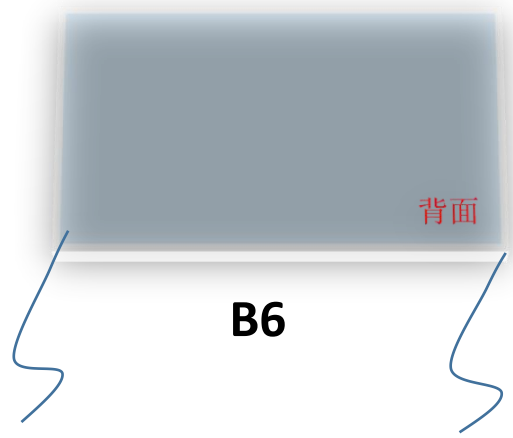

**B5**



**B6**

## AC DC线缆规格表

### AC插头列表

类型	A IEC320-C14 (Class I)	B IEC320-C8 (Class II)	U 2 Pole USA plug (Class II)	E 2 Pole EURO Plug (Class II)	I Interchangeable (Class II)
					
工控	GST, GS, GP 系列	GST, GS, GP 系列	GST, GS, SGA 系列	GST, GS, SGA 系列	GE 系列
医疗	GSM 系列	GSM 系列	GSM 系列	GSM 系列	GEM 系列
其他	NA	GSC 系列	OWA 系列	OWA, GSC 系列	NA

### 可选DC输出头列表

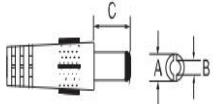
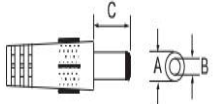
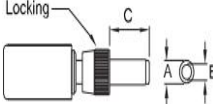
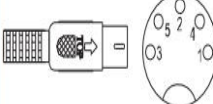
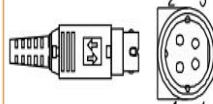
Tuning Fork Style				Barrel Style				Lock Style				DIN 5 Pin			DIN 4 Pin with lock			
																		
型号	A	B	C	型号	A	B	C	型号	A	B	C	型号	Pin Assignment		型号	Pin Assignment		
	OD	ID	L		OD	ID	L		OD	ID	L		Single	Triple		PIN No.	Output	
P1I	5.5	2.1	9.5	P2I	5.5	2.1	9.5	P2S (S761K)	5.53	2.03	12.06	R1B	1	COM	COM	R7B	1	+Vout
P1J	5.5	2.1	11.0	P2J	5.5	2.1	11.0						2	COM	COM		2	GND
P1L	5.5	2.5	9.5	P2L	5.5	2.5	9.5						3	Vout	+5V		3	GND
P1M	5.5	2.5	11.0	P2M	5.5	2.5	11.0						4	COM	-Vout		4	+Vout
								5	Vout	+Vout								

# 拆箱须知

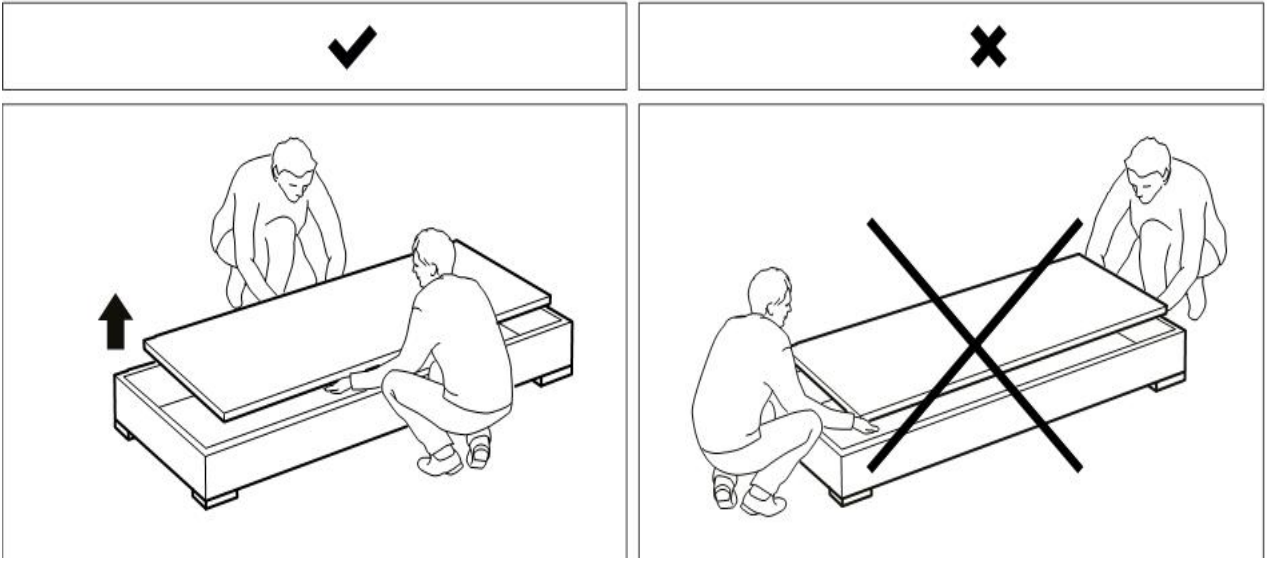

当你收到YEEHUI公司生产的发光板的时候，请正确的打开木箱轻轻的在边缘垂直方向取出LED发光板，请看示意图。

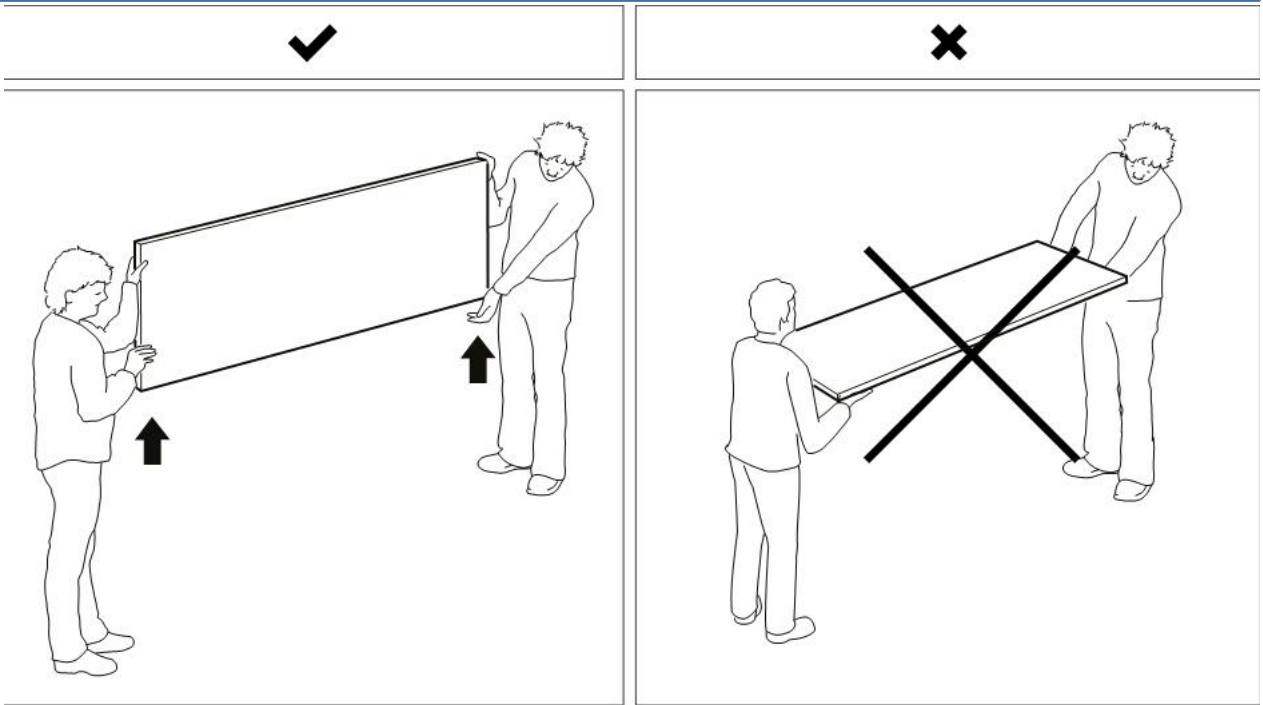

请垂直抬起YEEHUI发光板，防止弯曲和弯曲的一切可能性。  
特别注意不要拉扯电缆，避免线缆拉扯断。

# 安装示意图

A

磁吸式安装方式

1. 将磁吸条安装在墙上

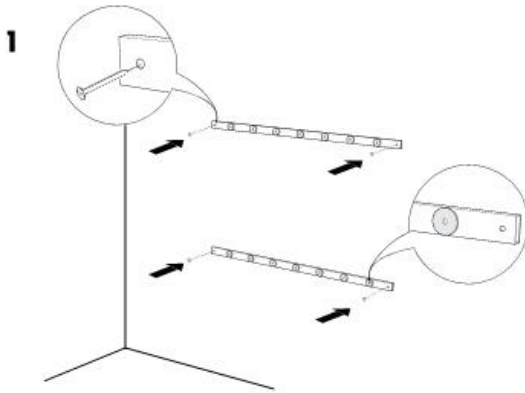

2

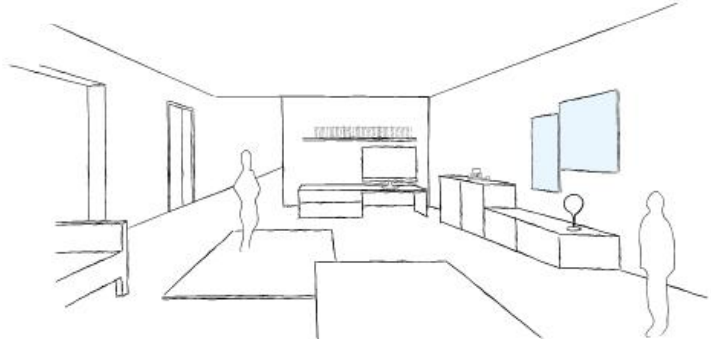
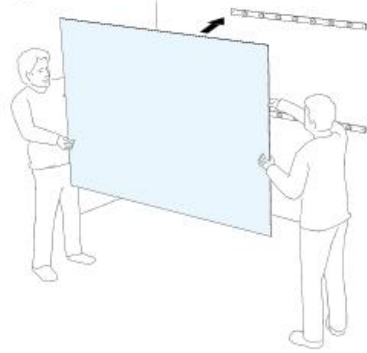

B

侧挂式安装方式

1

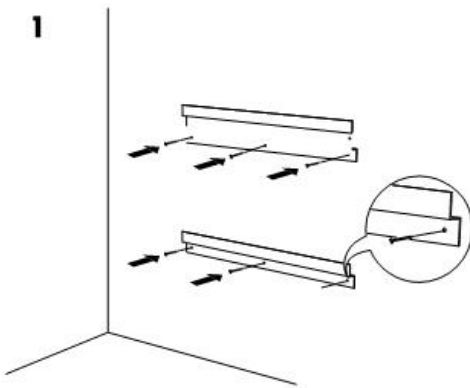

2

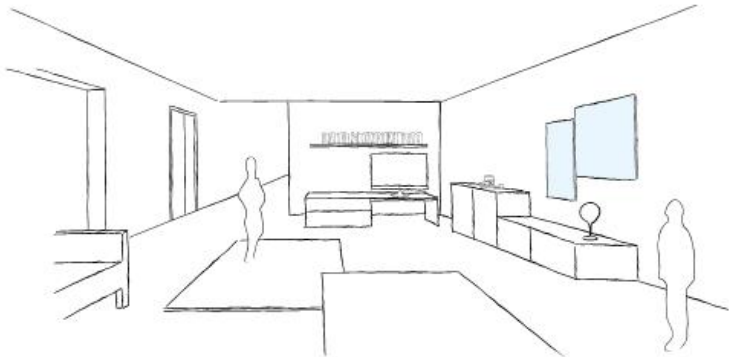
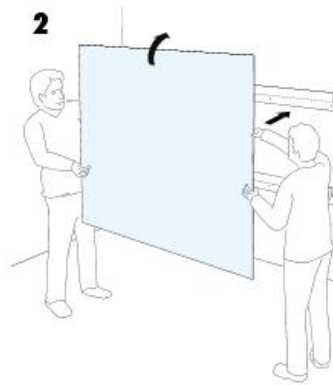



# 安装示意图

C

吊挂式安装方式

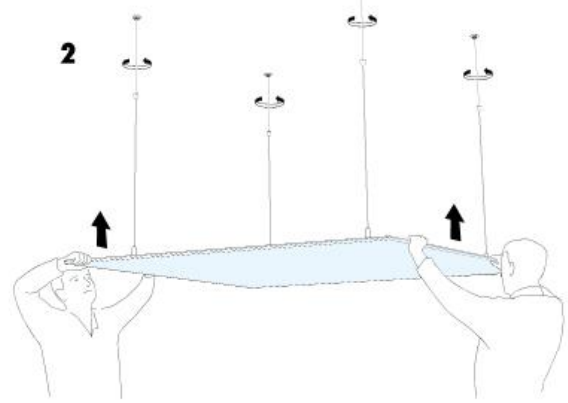
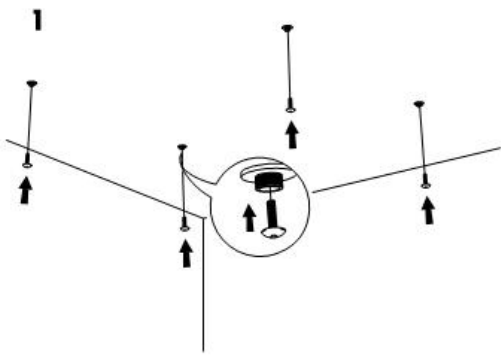
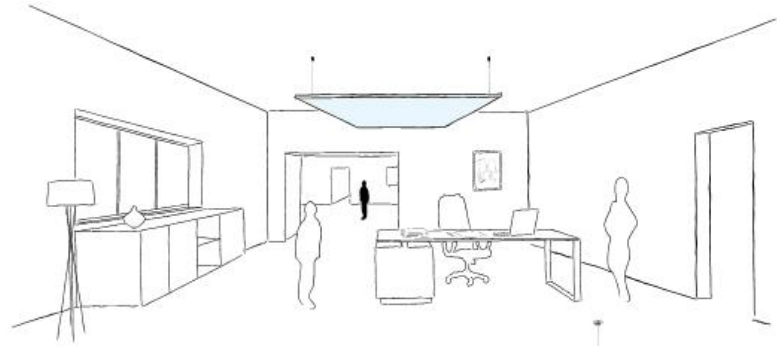

D

吸顶式安装方式

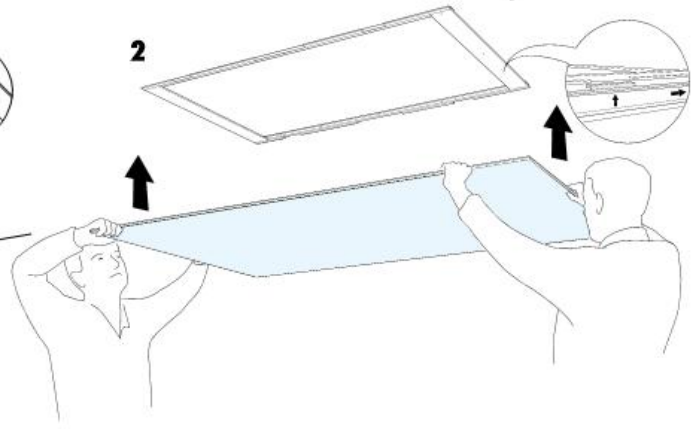
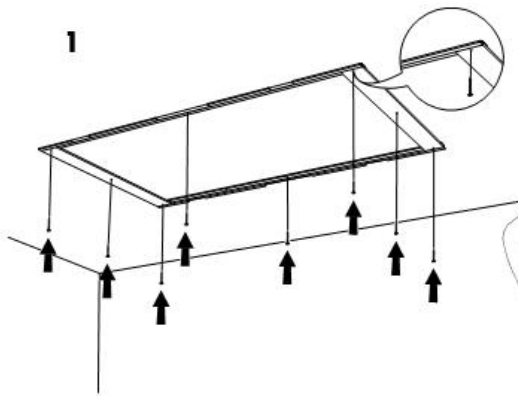
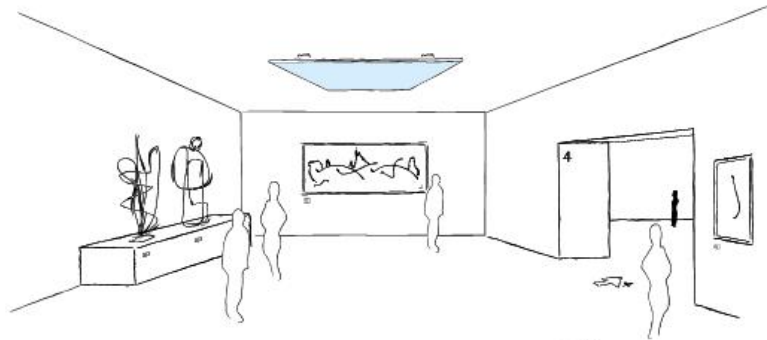

# 灯板接电示意图

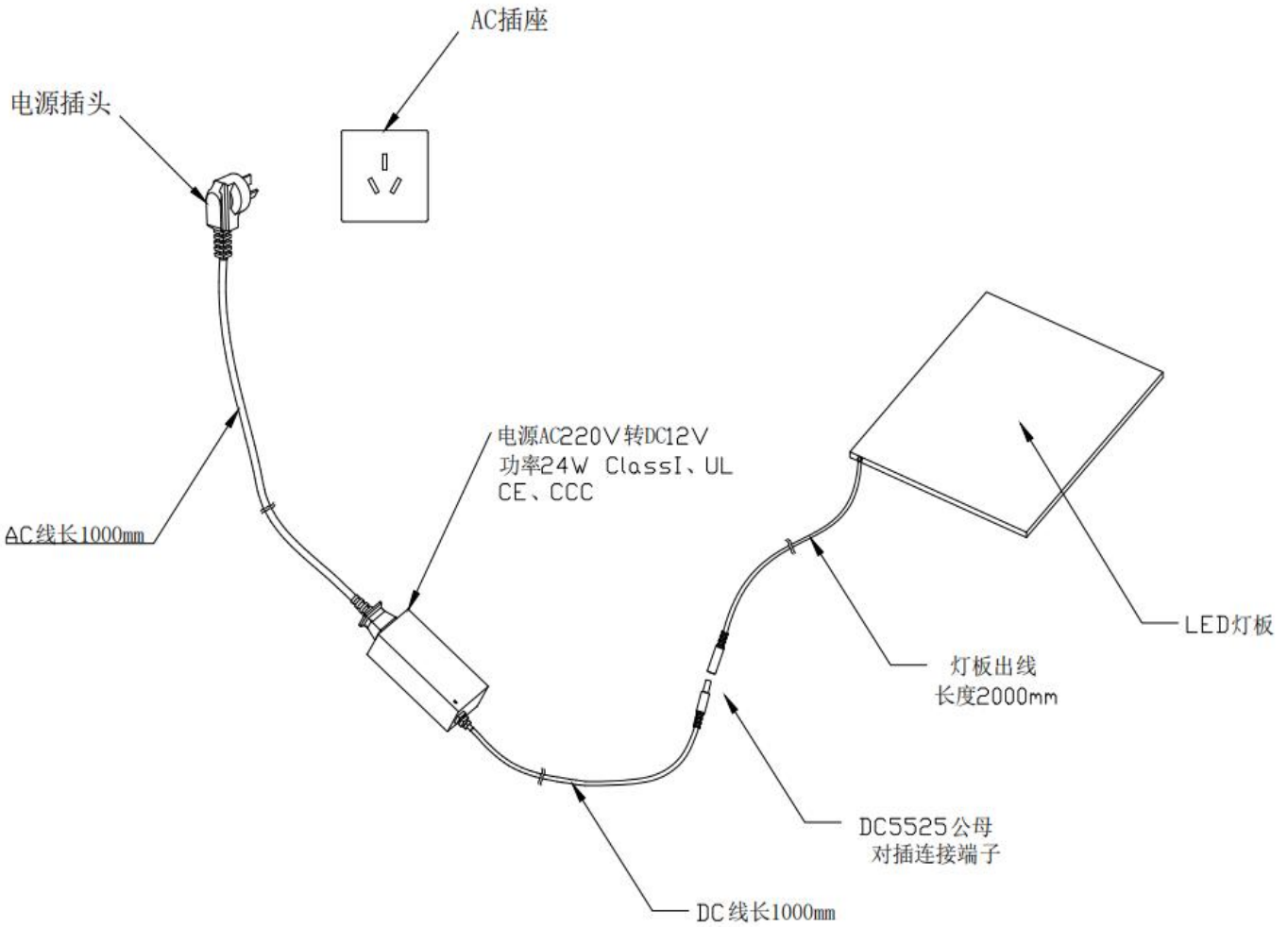

## 安全使用注意事项

- ※在使用之前，需确认产品在运输中有没有被损坏，若有损坏就不能安装使用
- ※不要尝试自己维修，只能由专业工程师去维修
- ※包装材料要远离小孩，防止小孩玩弄导致窒息
- ※防止产品小的配件被小孩吞食
- ※让小孩远离产品，更不要让小孩接触带电设备
- ※避免长时间直视LED的发光面，不要用反射的LED的光去照射别人的眼睛
- ※产品要远离明火或高温物体
- ※产品过了使用期限，需要重新维修检查，或报废处理

## 保养注意事项

- ※在清洁灯具之前，请一定要关闭电源
- ※请用干燥或较干燥的抹布进行清洁
- ※不要使用化学或有腐蚀性的东西去清洁

## 旧品处理

- ※所有部件均可回收利用

## 安装注意事项

- ※产品的安装必须是持证的专业电工
- ※从包装箱里拿出时要检查产品的完整性
- ※产品与易燃材料要保证至少0.2m 距离。
- ※要确保灯具的电源线有足够的长度，不要受到张力或切向力。安装灯具的连线时避免过大的拉力，不要使连线打结。输出连线要注意区分，不要和其它灯具混淆
- ※安装好后，将灯具低压插头与开关电源低压插头进行连接
- ※将灯具的开关电源尾巴连线与市电进行连接，通常棕色（黑色）线为火线，蓝色（白色）为零线。
- ※要使用灯具的LED专用驱动器，不要和其它的灯具混用
- ※不要将灯具电源，驱动器的铭牌撕掉

## 注意事项

- ※非专业人员不得进行拆卸、维修，我司有权对私自拆卸、维修的产品不给予更换或保修的服务。



# C E R T I F I C A T E

## ATTESTATION CERTIFICATE OF ELECTROMAGNETIC COMPATIBILITY DIRECTIVE

Technical file of the company mentioned below has been observed and audit has been completed successfully.

2014/ 30/EU Electromagnetic Compatibility Directive has been taken as references for these processes

Company Name : **Kunshan Lai Ze Optoelectronic Technology Co., Ltd.**

Company Address : Building 3, 9 Jinchang Road, Jinxi Town, Kunshan City, Jiangsu Province, China

Related Directives and Annex : **Electromagnetic Compatibility 2014/30/EU**

Related Standards : **EN 55015:2013/A1:2015; EN 61547:2009  
EN 61000-3-2:2019; EN 61000-3-3:2013+A1:2019**

Product Name : **LED Light Panel**

Report No and Date : **BSTXD200714078802ER**

Product Brand/Model/Type : **AF1013,AF0710,AF0808, AF1515,DF4525,PF1002,LED-LGP, AO1920,AO2335,AO3035,AO2523,AO2517,DO2823,DO3530, AF1702,AF3302,AF4304,AF4602,DF7102,CSL,CDL,CSM,CDM, AF-XXYY(X:0-9,Y:0-9);DF-XXYY(X:0-9,Y:0-9); AO-XXYY(X:0-9,Y:0-9); DO-XXYY(X:0-9,Y:0-9); AM-XXYY(X:0-9,Y:0-9);PF-XXYY(X:0-9,Y:0-9); LAZ-XXYY("X"and"Y"may be any alphanumeric characters)**

Certificate Number : **M.2020.206.C8293**

Initial Assessment Date : 10.08.2020

Registration Date : 11.08.2020

Reissue Date/No : -

**Expiry Date : 10.08.2025**

  
UDEM International Certification  
Auditing Training Centre Industry  
and Trade Inc. Co.

The validity of the certificate can be checked through [www.udem.com.tr](http://www.udem.com.tr). The CE mark shown on the right can only be used under the responsibility of the manufacturer with the completion of EC Declaration of Conformity for all the relevant Directives. This certificate remains the property of UDEM International Certification Auditing Training Centre Industry and Trade Inc. Co. to whom it must be returned upon request. The above named firm must keep a copy of this certificate for 15 years from the registration of certificate. This certificate only covers the product(s) stated above and UDEM. must be noticed in case of any changes on the product(s)

**Address:** Mutlukent Mahallesi 2073 Sokak (Eski 93 Sokak) No:10 Çankaya – Ankara – TURKEY  
**Phone:** +90 0312 443 03 90 **Fax:** +90 0312 443 03 76  
**E-mail:** [info@udemltd.com.tr](mailto:info@udemltd.com.tr) [www.udem.com.tr](http://www.udem.com.tr)





**BST** | A RELIABLE TESTING FOR TRUST  
GLOBAL TESTING AND CERTIFICATION PRECISION SERVICE CLOUD FACTORY

# Certificate of Compliance

**Certificate Number: BSTSH200814077101CC**

**Applicant** : KUNSHAN LAI ZE OPTOELECTRONIC TECHNOLOGY CO., LTD.  
 Building 3, 9 Jinchang Road, Jinxi Town, Kunshan City,  
 Jiangsu Province, China

**Manufacturer** : KUNSHAN LAI ZE OPTOELECTRONIC TECHNOLOGY CO., LTD.  
 Building 3, 9 Jinchang Road, Jinxi Town, Kunshan City,  
 Jiangsu Province, China

**Product Name** : LED LIGHT PANEL

**Main Test Model** : AF1013

**Additional Model** : AF0710, AF0808, AF1515, DF4525, PF1002, LED-LGP,  
 AO1920, AO2335, AO3035, AO2523, AO2517, DO2823, DO3530,  
 AF1702, AF3302, AF4304, AF4602, DF7102, CSL, CDL, CSM, CDM,  
 AF-XXYY(X:0-9, Y:0-9); DF-XXYY(X:0-9, Y:0-9);  
 AO-XXYY(X:0-9, Y:0-9); DO-XXYY(X:0-9, Y:0-9);  
 AM-XXYY(X:0-9, Y:0-9); PF-XXYY(X:0-9, Y:0-9);  
 LAZ-XXYY("X" and "Y" may be any alphanumeric characters)

**Test Standard** : IEC 62321-4:2013+AMD1:2017, IEC 62321-5:2013,  
 IEC 62321-6:2015, IEC 62321-7-1:2015,  
 IEC 62321-7-2:2017, IEC 62321-8:2017

**As shown in the Test Report No.** : BSTSH200814077101CR

The EUT described above has been tested by us and found in compliance with the council RoHS 2 Directive 2011/65/EU Annex II (EU) 2015/863 as last amended by Directive (EU) 2017/2102. This certificate is only valid in conjunction with the test report.



## RoHS



Tony Qian  
 Approved Signatory  
 Aug.14, 2020

**Dongguan BST Testing Co., Ltd**

Add: A1201-1204 Xinsanqi Of Dongbao Road, Dongcheng District, Dongguan, Guangdong, China

Certificate Search: <http://www.bst-lab.com>, Tel:400-882-9628, 8009990305, E-mail:christina@bst-lab.com

# CERTIFICATE OF COMPLIANCE

**Certificate Number** E518774  
**Report Reference** E518774-20210305  
**Date** 2021-April-01

**Issued to:** Kunshan Lai Ze Optoelectronic Technology Co.,Ltd  
Building 3, 9 Jinchang Road, Jinxi Town  
KunshanJiangsu 215324 CN

**This is to certify that  
representative samples of**

**SIGN ACCESSORIES - COMPONENT**  
See Addendum Page for Product Designation(s).

Have been investigated by UL in accordance with the component requirements in the Standard(s) indicated on this Certificate. UL Recognized components are incomplete in certain constructional features or restricted in performance capabilities and are intended for installation in complete equipment submitted for investigation to UL LLC.

**Standard(s) for Safety:** UL 879 - Electric Sign Components  
CAN/CSA-C22.2 No. 207-15 - Portable and Stationary Electric Signs and Displays

**Additional Information:** See the UL Online Certifications Directory at <https://iq.ulprospector.com> for additional information

This *Certificate of Compliance* does not provide authorization to apply the UL Recognized Component Mark. Only the UL Follow-Up Services Procedure provides authorization to apply the UL Mark.

Only those products bearing the UL Recognized Component Mark should be considered as being UL Certified and covered under UL's Follow-Up Services.

Look for the UL Recognized Component Mark on the product.

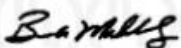

Bruce Mahrenholz, Director North American Certification Program

UL LLC

Any information and documentation involving UL Mark services are provided on behalf of UL LLC (UL) or any authorized licensee of UL. For questions, please contact a local UL Customer Service Representative at <http://ul.com/about/locations/>





上海熠卉光电科技有限公司  
Shanghai Yihui Photoelectric Technology Co., Ltd  
昆山莱泽光电科技有限公司  
Kunshan Laize Photoelectric Technology Co., Ltd  
江苏省昆山市淀山湖镇新华路28号  
NO. 28 Xinhua Road, Dianshanhu Town, Kunshan City, Jiangsu Province  
Tel: (+86 0512) 50122891 / Fax: (+86 0512) 50122891  
Mobile: +86 13917329149  
[www.yh-lighting.cn](http://www.yh-lighting.cn) & [chenjianwei\\_laz@163.com](mailto:chenjianwei_laz@163.com)

